

FRENCH FITNESS

FF-SE100

**FRENCH FITNESS SE100 RECUMBENT SEATED
ELLIPTICAL W/LED CONSOLE (NEW)**

OWNER'S AND ASSEMBLY MANUAL



Before using this product, read all instructions in the document provided with our exercise equipment, including all assembly guides, user guides, and owner's manuals, before installation of this device.

FEATURES

- LED Display
- With Heart Rate Sensor on handles on both sides
- Multi-Grip Handlebars for arms workout
- Step-through open area on both sides of the machine for easy access
- Display: Distance, Heart Rate, Calories, Time, Speed
- 4 Self-Compiled Programs
- 8 Preset Programs
- Transmission Type: Multi Wedge Belt Drive
- Resistance: EMS system with flywheel
- Flywheel: 20 lbs (9 kg)
- Resistance Level: 1-25 levels
- Seat Adjustment: Hydraulic Cylinder (Vertical & Horizontal)
- Power Requirements: AC110V-240V

TECH SPECS

- Main Tube Size: 2.4" x 4.7" (60mm x 120mm)
- Main Tube Thickness: 3mm
- Max User Weight: 330 lbs (150 kg)
- User Height Range: 5'6" to 8'3" (140cm to 120cm)
- Product Weight: 396.8 lbs (180 kg)
- Dimensions: 80"L x 39.8"W x 59.8"H (203cm x 101cm x 152cm)

WARRANTY

- **10 Years Parts, 1 Year Labor (Commercial)**
- **California Residents see Prop 65 WARNING**

TABLE OF CONTENTS

IMPORTANT SAFETY INSTRUCTIONS	4
OTHER IMPORTANT SAFETY INSTRUCTIONS	5
ASSEMBLY INSTRUCTIONS	6
PARTS LIST	7
EXPLODED VIEW	8
ASSEMBLY STEPS	9
CONSOLE DESCRIPTION-LED	18
CONSOLE DESCRIPTION-TFT	19
CONSOLE DESCRIPTION	20
OPERATING INSTRUCTIONS	21
EXERCISE INSTRUCTIONS	22
MAINTENANCE	23

IMPORTANT SAFETY INSTRUCTIONS

WARNING

Save these instructions for future reference.

WARNING

Make sure all users see a physician for a complete physical examination before they begin any fitness program, particularly if they have high blood pressure, high cholesterol or heart disease; have a family history of any of the preceding condition; are over the age of 35; smoke; are obese; have not exercised regularly in the past year; or are taking any medication.

Safety Precautions

Always follow basic safety precautions when using this equipment to reduce the chance of injury, fire, or damage. Other sections in this manual provide more details of safety features. Be sure to read these sections and observe all safety notices. These precautions include the following:

- Read all instruction in this guide before installing and using the equipment and follow any labels on the equipment.
- Make sure all users see a physician for a complete physical examination before they begin any fitness program.
- Do not allow Children, or people unfamiliar with the operation of this equipment, on or near it. Do not leave children unsupervised around the equipment.
- Make sure all users wear proper exercise clothing and shoes for their workouts and avoid loose or dangling clothing. Users should not wear shoes with heels or leather soles, and they should check the soles of their shoes to remove any dirt and embedded stones. They should also tie long hair back.
- Never leave the equipment unattended when it is plugged in. Unplug the equipment from its power source when it is not in use, before cleaning it, and before providing authorized service.
- Use the power adapter provided with the equipment. Plug the power adapter into an appropriate, grounded power outlet as marked on the equipment.
- Care should be taken when mounting or dismounting the equipment.
- Read, understand, and test the emergency stop procedures before use.
- Keep the power cord or optional power adapter and plug away from heated surfaces.
- Route power cables so that they are not walked on, pinched, or damaged by items placed upon or against them, including the equipment itself.
- Ensure the equipment has adequate ventilation. Do not place anything on top of or over the equipment. Do not use on a cushioned surface that could block the ventilation opening.
- Assemble and operate the equipment on a solid, level surface.
- Place the unit on a level surface, there should be 1 meter of clearance from each side. Treadmill, there should be 2 meters of clearance from each side.

OTHER IMPORTANT SAFETY INSTRUCTIONS

- Keep equipment away from water and moisture. Avoid dropping anything on or spilling anything inside the equipment to prevent electric shock or damage to the electronics.
- Do not operate electrically powered equipment in damp or wet locations.
- Never operate this equipment if it has a damaged cord or plug, If it is not working properly, or if it has been dropped, damaged, or exposed to water, call for service immediately if any of these conditions exist.
- Maintain the equipment to keep it in good working condition, as described in the maintenance section of the owner's manual. Inspect the equipment for incorrect, worn, or loose components, and then correct, replace or tighten prior to use.
- Equipment Weight Restrictions: Do not use the unit if you weigh more than 180kg.
- Use the Equipment only for its intended purpose as described in this manual. Do not use accessory attachments that are not recommended. Such attachments
- many cause injuries.
- Do not operate the equipment where aerosol(spray) products are being used or where oxygen is being administered.
- Do not use outdoors.
- Do not attempt to service the equipment yourself, except to follow the maintenance instructions in the owner's manual.
- Never drop or insert objects into any opening. Keep hands away from moving parts. Do not set anything on the stationary handrails, handlebars, control console, or covers. Place liquids, magazines, and books in the appropriate receptacles.
- Do not lean on or pull on the console at any time.



Caution: Do not remove the cover, or you may risk injury due to electric shock. Read the assembly and maintenance guide before operating. There are no user-serviceable parts inside.

Contact customer support if the equipment needs servicing.

ASSEMBLY INSTRUCTIONS

DANGER!

Always unplug the unit from the electrical outlet immediately after using, before cleaning, performing maintenance and putting on or taking off parts.

- Read all instructions in this guide before installing.
- Assemble and operate your equipment on a hard, level surface in the area intended for use.
- Open the box and assemble the components in the sequence presented in this guide.
- Attach all fasteners and partially tighten them. Do not fully tighten fasteners until instructed to do so.
- Do not attempt to move equipment by yourself.
- Has at least one other person help you, and use safe lifting techniques. Do not grasp any plastic parts of the unit while lifting or moving the unit.
- The plastic parts are non-structural covers and are not capable of supporting the weight of the unit.

HARDWARE PACK

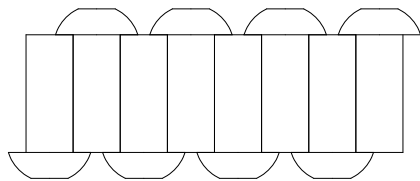

M10×25 Button Head Cap Screw (pcs8)

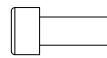

M6×15 Socket Head Cap Screw (pcs1)

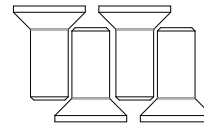

Flat Head Cap Screw M8×20 (pcs4)

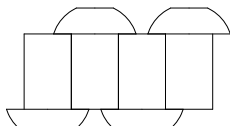

M10×16 Button Head Cap Screw (pcs4)

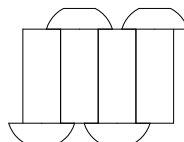

M8×20 Button Head Cap Screw (pcs4)



M5×12 Cross Recessed Pan Head Screw (pcs2)

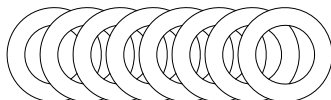

Φ10 Flat Washer (pcs8)

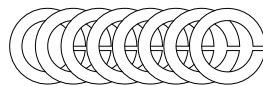

Φ10 Spring Washer (pcs8)



Φ8 Flat Washer (pcs4)

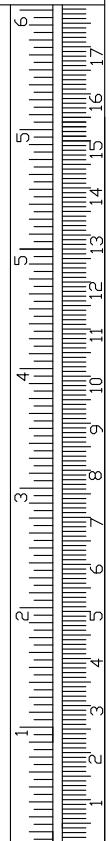

PARTS LIST

Note: some of these parts may come pre-installed.

Part No.	DESC.	Qty/Unit
1	Main Frame Assembly	1
2	Left Arm Assembly	1
3	Right Arm Assembly	1
4	Right Pedal Assembly	1
5	Back Pad	1
6	Back Pad Rear Cover	1
7	Front Handle Cover	2
8	Rear Handle Cover	2
9	Bottle Holder	1
10	Console Assembly	1
11	Bolt M10x25	8
12	Bolt M10x16	4
13	Bolt M8x20	4
14	Bolt M8x20	4
15	Bolt M6x15	1
16	Bolt M5x12	2
17	Tapping Screw ST4x15	8
18	Flat Spacer $\Phi 11 \times \Phi 20 \times 2$	8
19	Spring Washer $\Phi 10$	8
20	Flat Spacer $\Phi 8.5 \times \Phi 16 \times 1.5$	4

EXPLODED VIEW

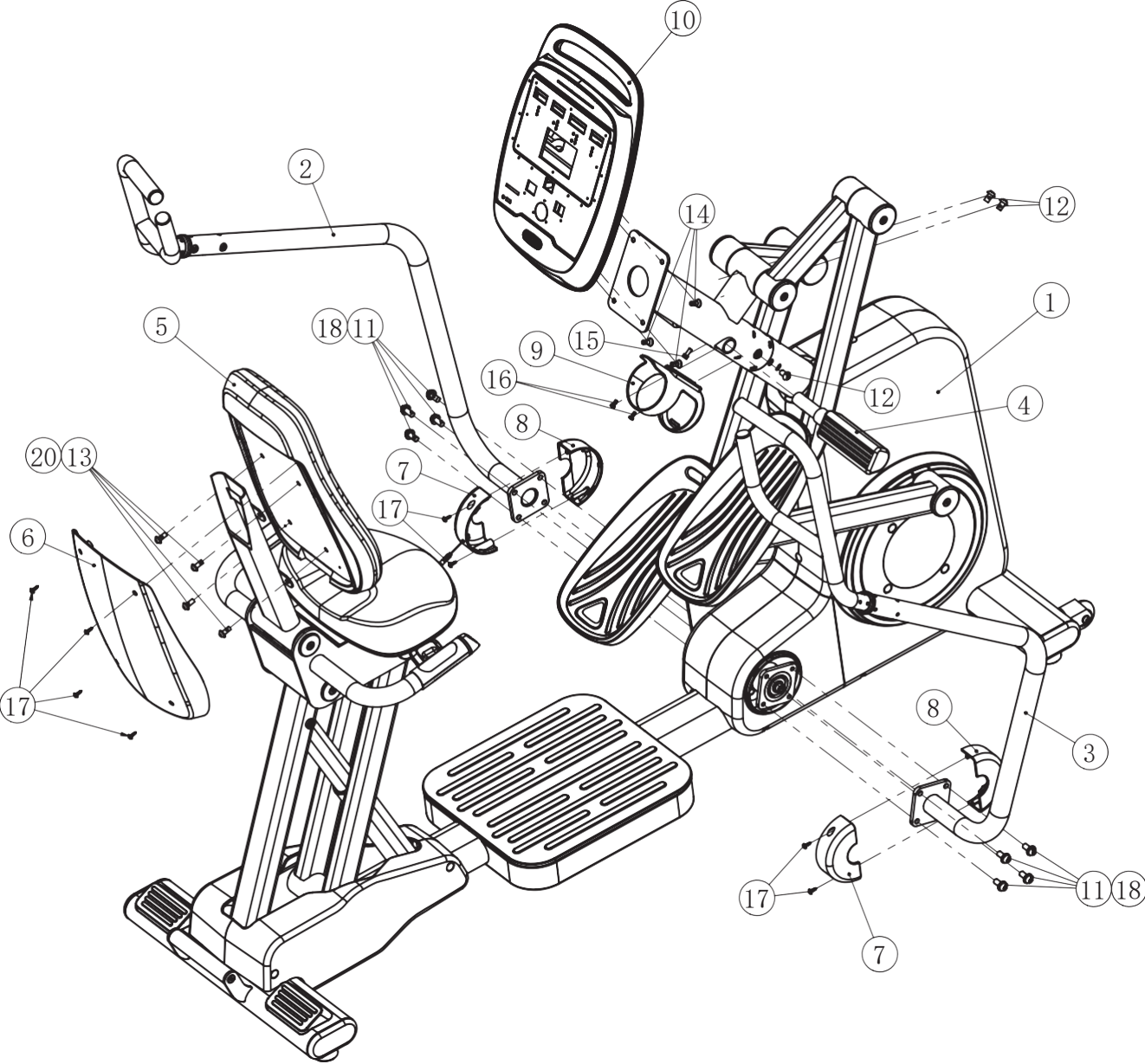

ASSEMBLY STEPS

Step 1

1. Remove the left and right handrails from the machine first.
2. Remove the packing connecting frame group welding from the machine. Note, be careful of pinching hands and touching the plastic shell. (Two people are required for this installation)

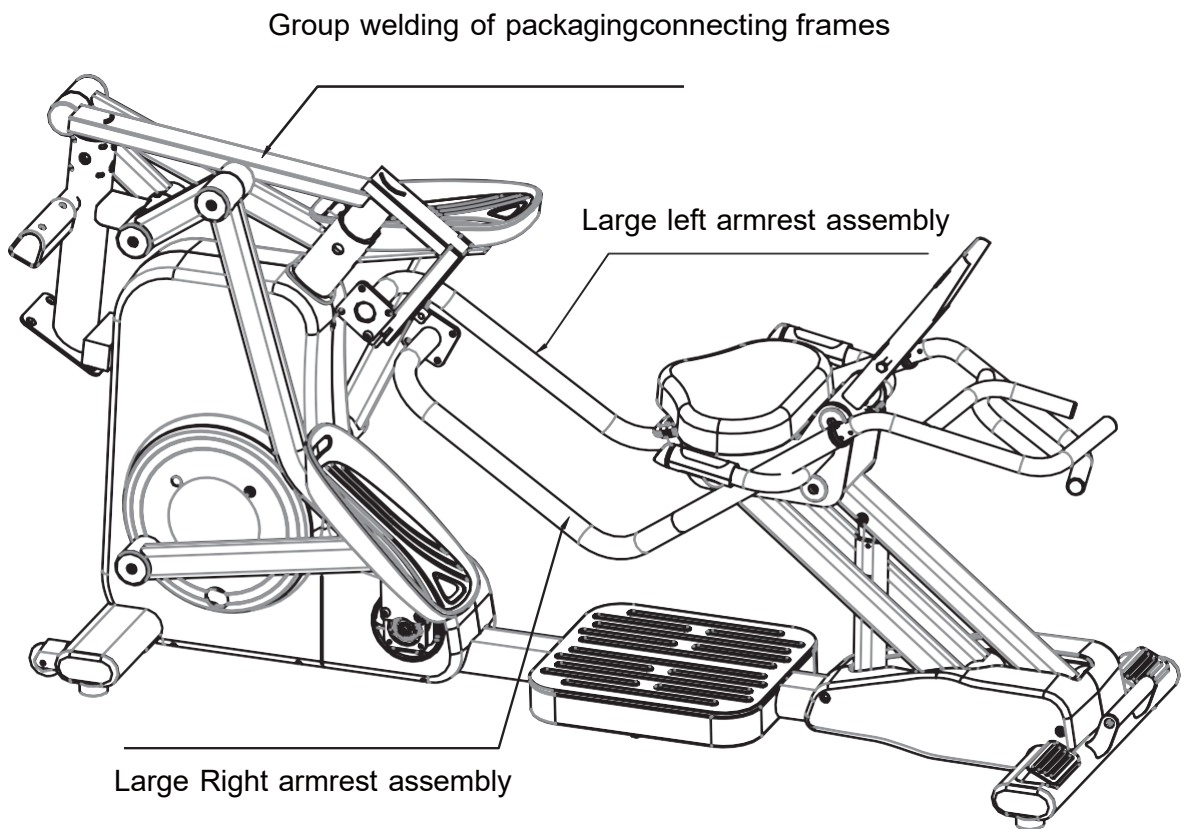

ASSEMBLY STEPS

Step 2

1. Rotate the upper support bracket group weld to the position shown in the illustration (note, be careful of pinching hands).
2. Pass the communication cable through the upper support bracket.
3. Pre-insert the upper support bracket into the main frame in the position shown in the picture (a person needs to hold it).
4. Another person removes the package fixing plate and welds it. (Two people are required for this installation).

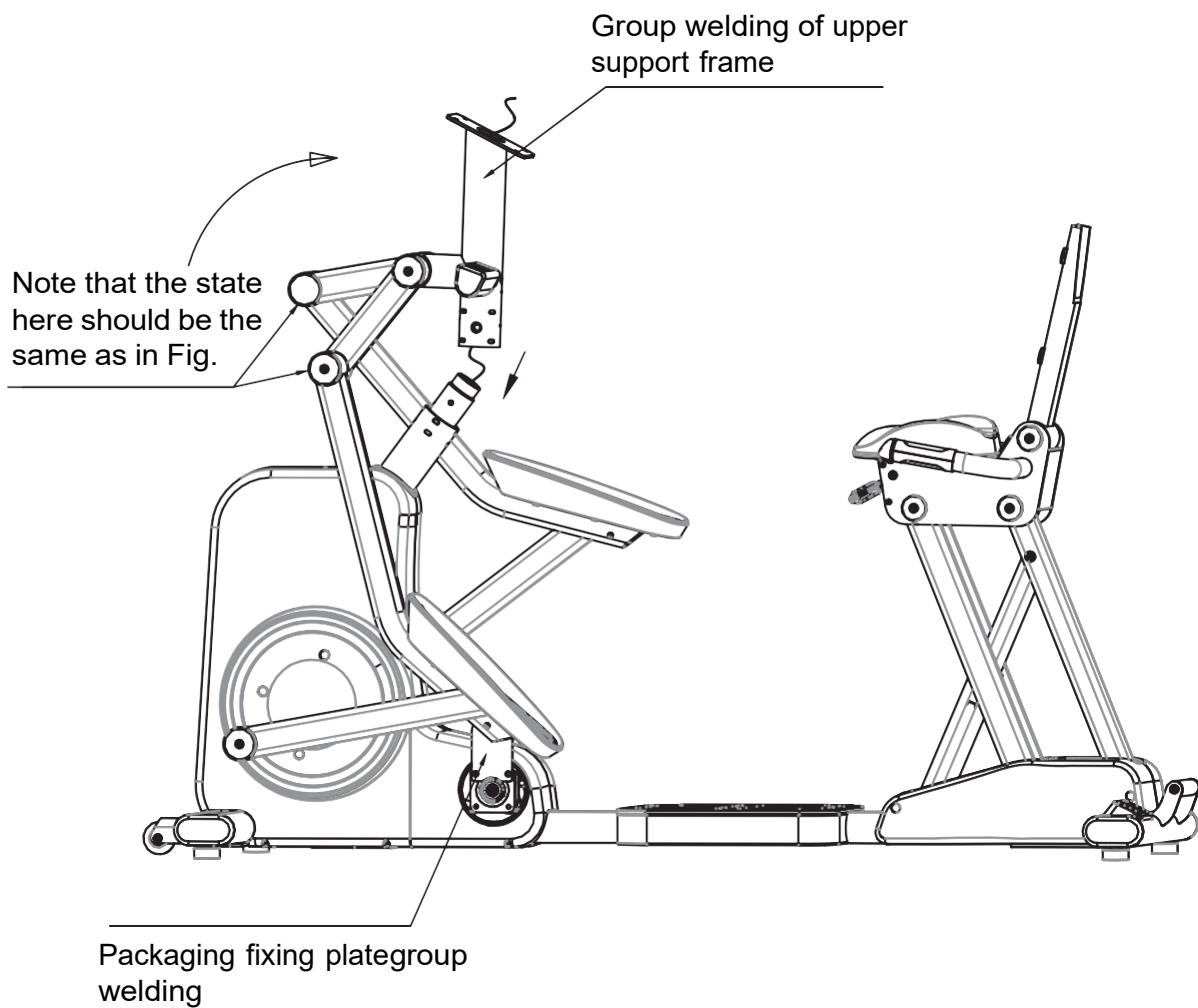

ASSEMBLY STEPS

Step 3

The upper support frame group welding is completely inserted on the main unit and fixed with M10x16 bolts.

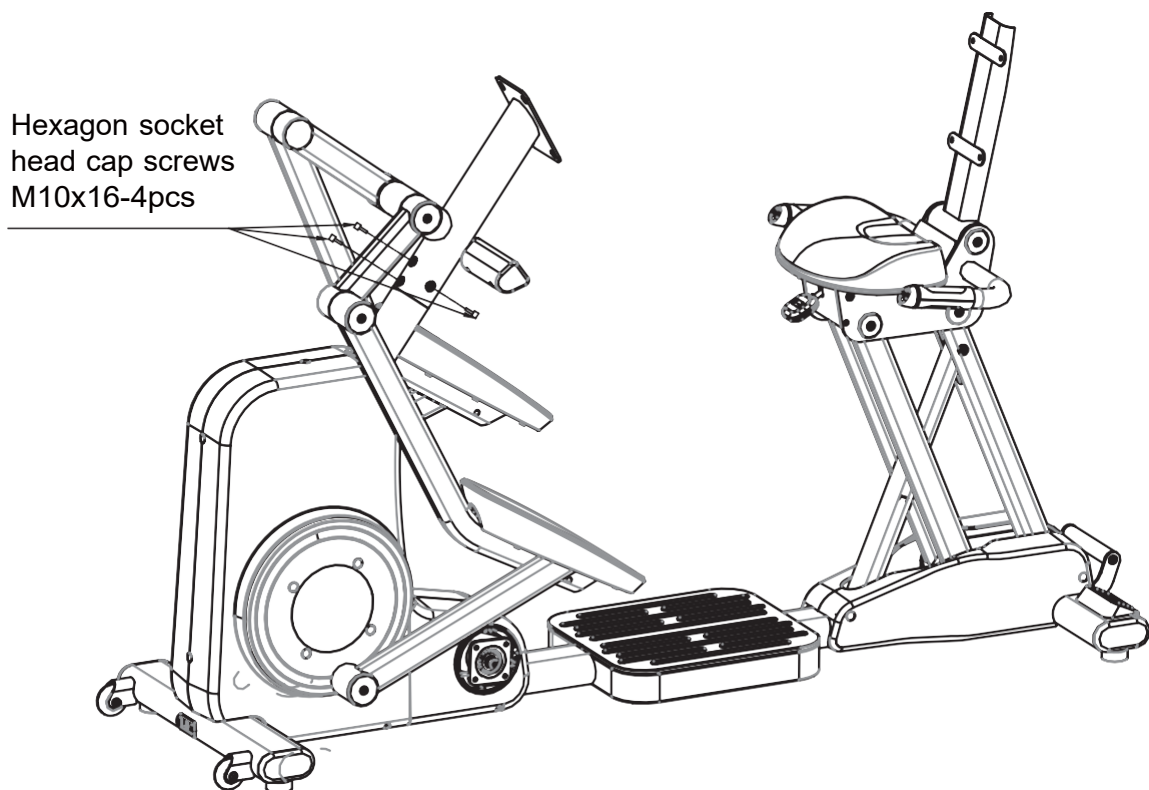

ASSEMBLY STEPS

Step 4

Insert the right stirrup assembly into the main unit according to the position shown in the picture and bolt it in place.

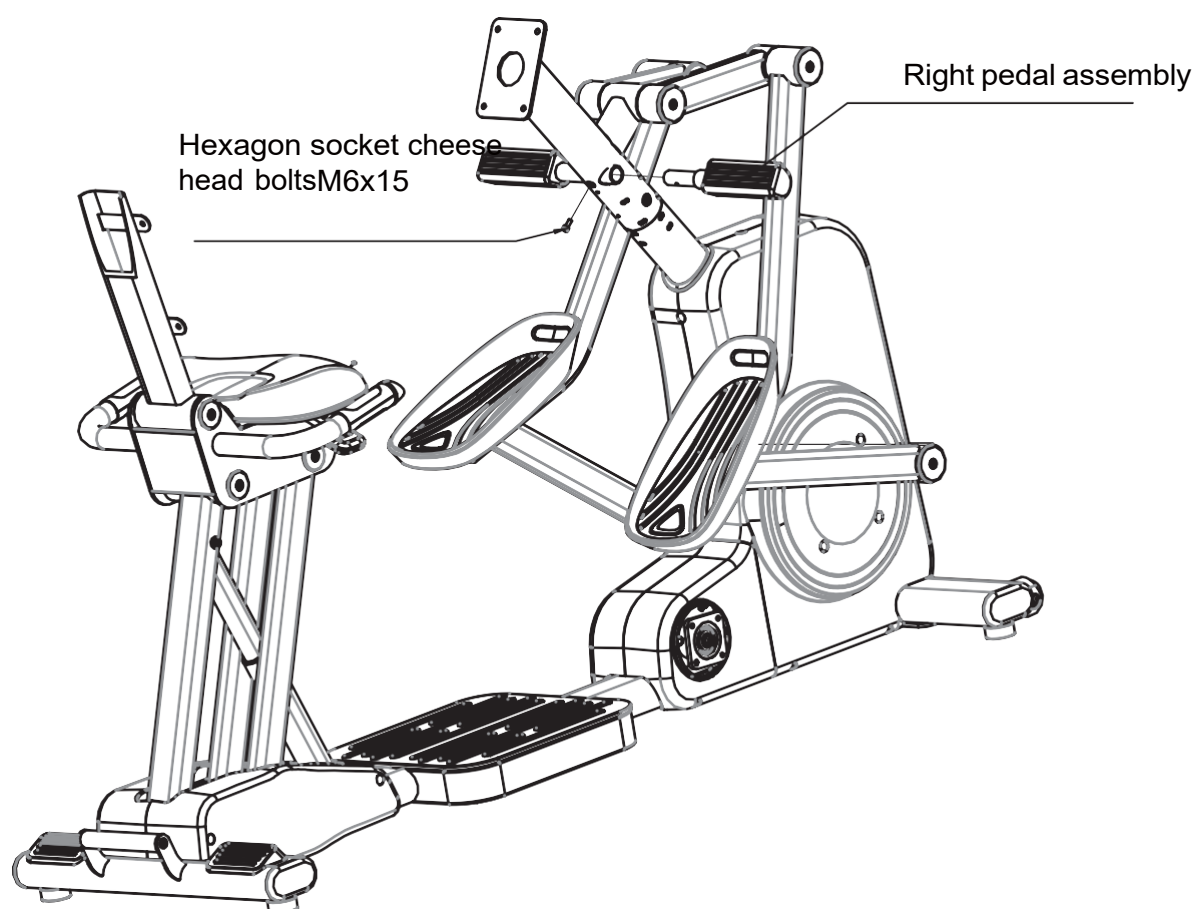

ASSEMBLY STEPS

Step 5

1. Fix the cup holder with bolts as shown in the figure.
2. Assemble the left and right large handrails and fix them with bolts according to the positions shown in the figure.

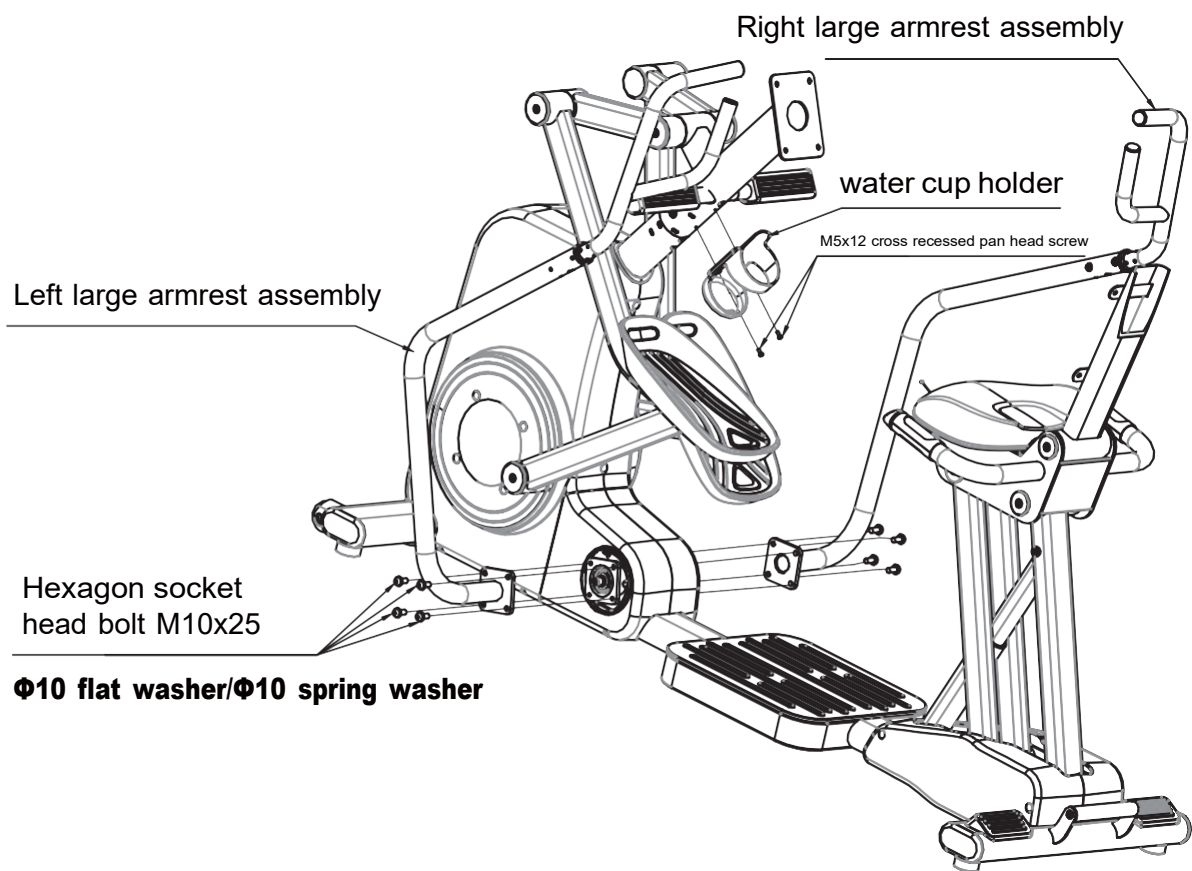

ASSEMBLY STEPS

Step 6

1. Attach the front and back of the armrest decorative cover to the main unit as shown in the figure.
2. Fix with self-tapping screws, same for left and right sides.

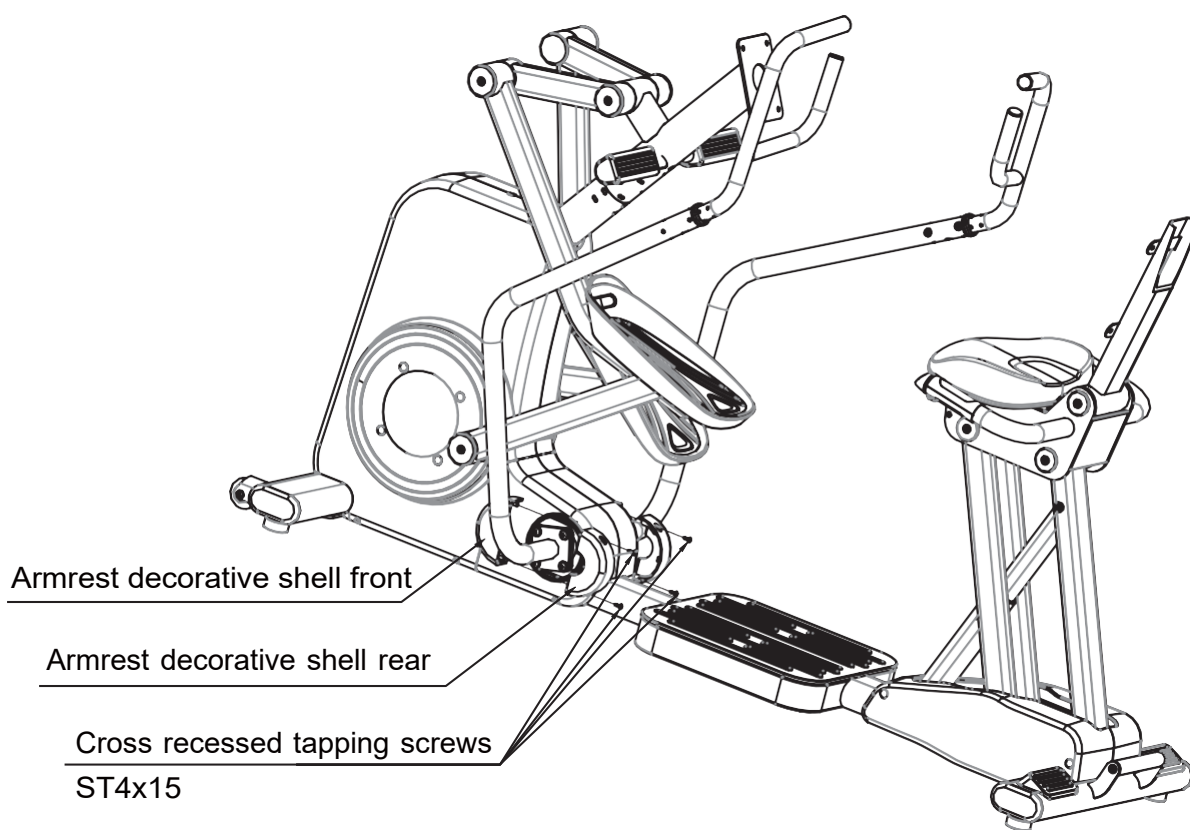

ASSEMBLY STEPS

Step 7

1. First connect the communication line in the electronic watch assembly with the communication line of the main body, as shown in the figure.
2. Assemble and install the electronic meter in the position shown in the figure and secure it with bolts.
3. Fasten the back cover of the electronic watch.

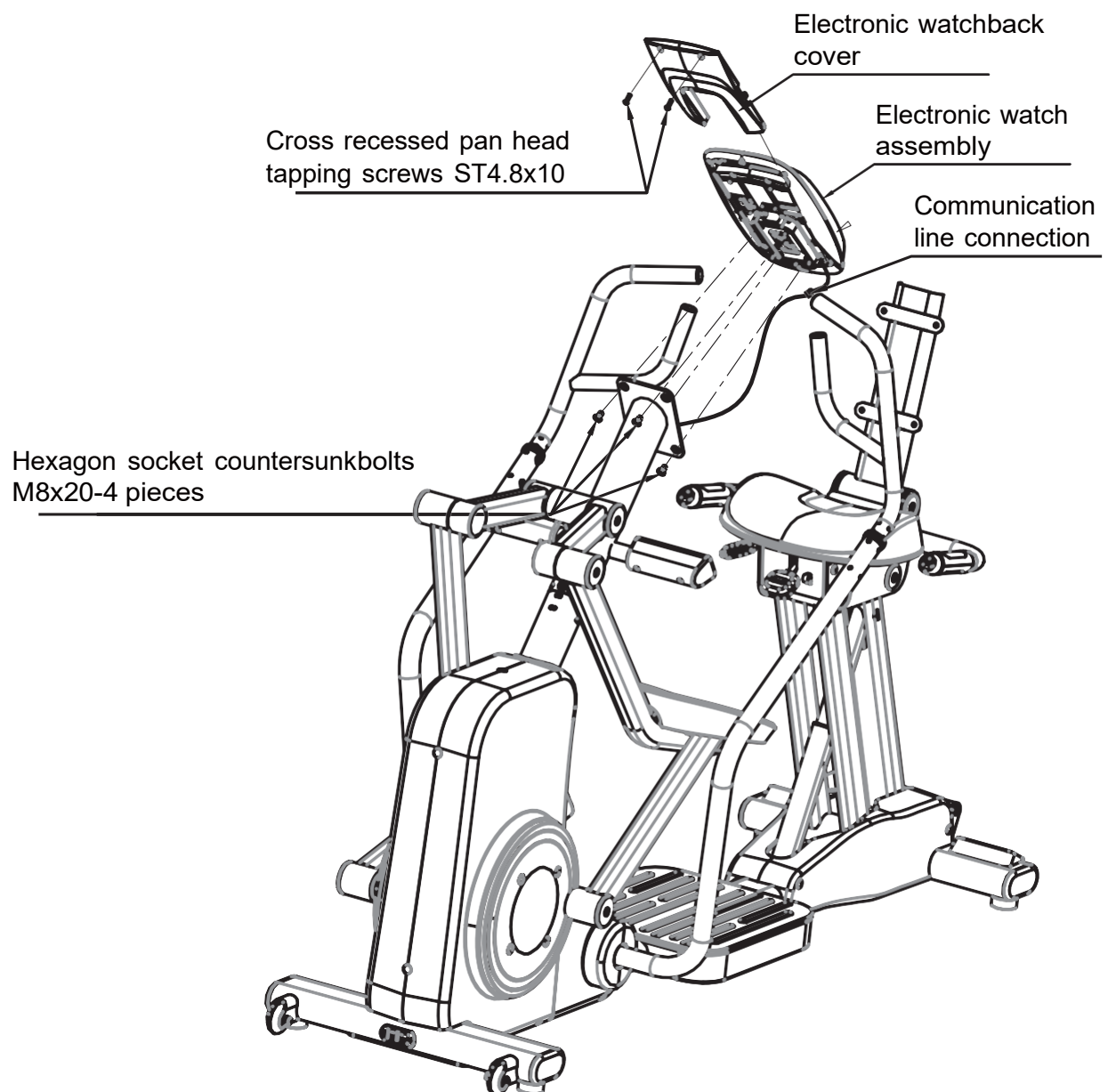

ASSEMBLY STEPS

Step 8

1. Fasten the back pad with bolts as shown in the figure.
2. Align the back cushion shell and back cushion as shown in the figure and fix them with self-tapping screws.

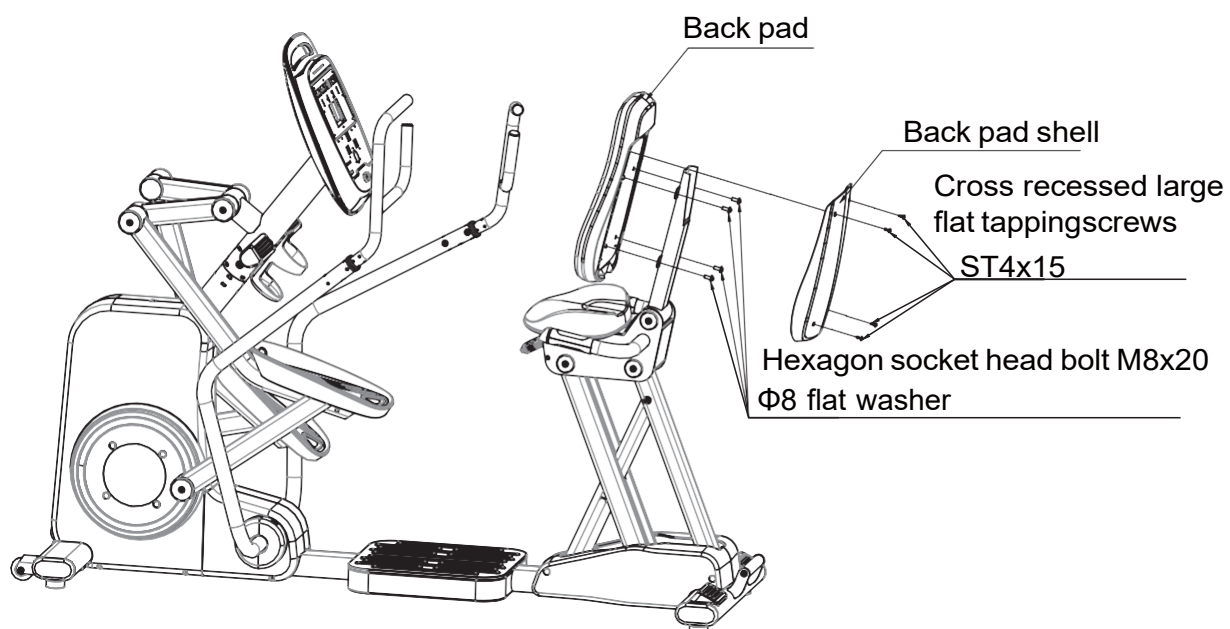

ASSEMBLY STEPS

Finished product

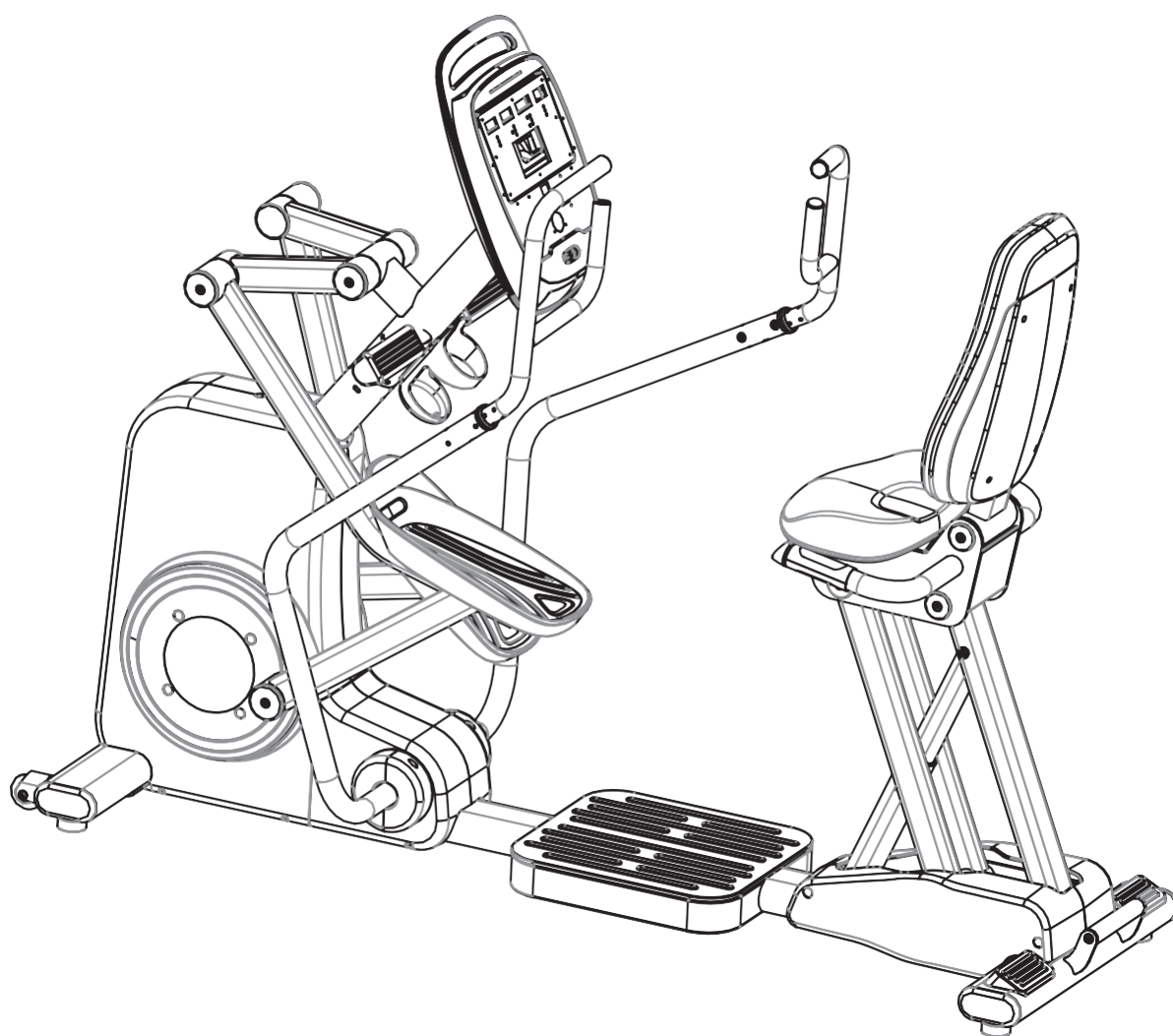

CONSOLE DESCRIPTION- LED

Display

LED display console, show us following information:

Time(S): display from "00:00-99:59" ; Default time for positive timing, Increment with each 1second.

Distance(Km): display from"0-99.9" ; Default distance is positive timing, increment witheach 0.1Km

Calorie (Kcal): display from"0-99.9" default Calorie is positive timing, Increment with each 0.1 Kcal.

Speed (Km/h): Display from"0-100km/h" Increment with each 0.1km/h

Intensity: display from "1-20" ;



CONSOLE DESCRIPTION- TFT

Display

LED display console, show us following information:

Time(S): display from "00:00-99:59" ; Default time for positive timing, Increment with each 1second.

Distance(Km): display from"0-99.9" ; Default distance is positive timing, increment witheach 0.1Km



Calorie (Kcal): display from"0-99.9" default Calorie is positive timing, Increment with each 0.1 Kcal.

Speed (Km/h): Display from"0-100km/h" Increment with each 0.1km/h

Intensity: display from "1-20" ;





CONSOLE DESCRIPTION

Number	Name	Details
①	light language	Blue(3seconds): Power On Breathing blue: Standby Flashing Blue: Searching bluetooth/ Logging into the system Green: System login succeeded Flashing Red(2sec): System login failed Yellow(60seconds): Pause state Blue(1Second):Cool Down Red(1second):Stop Red(2Second): Exit system
②	Distance Heart Rate Step Frequency	Use button to change
③	Koal Koal/ h Power	Use button to change
④	Used Time Remaining TimeSystem Time	Use button to change
⑤	Speed Average Speed Steps	Use button to change
⑥	LED display	Information about the training
⑦	Program	6 training modes, One button start
⑧	Numeric Keypad	Input the Age, weight and password etc. Press  to delete. After input the number, press OK to confirm.
⑨	View	After the end of the exercise, the system will automatically save the current exercise data, click on the view to display the current exercise result data
⑩	Fan	Adjust the speed of fan: low, high
⑪	Level	Press   adjust exercise intensity
⑫	Target Program	Set exercise target, include Time, distance, Koal
⑬	Self-editing Program	Set self-editing program
⑭	Start/Stop	When unit stopped, press this button to start. When unit running, press this button to stop.
⑮	NFC Identification	Identify user information (smart system version)

OPERATING INSTRUCTIONS

Quick start

Press  button, all data starts counting, The bottom line of display bright. display lights and intensity adjustment linkage; press buttons - + to adjust intensity, the data can be switched.

Press  button, to clear all the data, display remind "ANYKEY TO CONTINUE OR PRESS OK TO QUIT", press any key to continue use the unit, press  button to quit.

Preset program starting up



WARM UP



FAT BURNING



TRAINING





ROLLING HILLS





CHALLENGE









INTERVAL



Choose any program when LED display "START OR PRESS OK TO SET UP" Press  button, to start preset program, default time 30 min, level linkage adjustment. Press  button, to set program:

1, Age Setting(10-90): display remind "Enter your age"(input your age) default "35", press - + to choose or input your age directly, press  to next step; 2, weight Setting(30-180): display remind "Enter your weight"(input your weight) default "65", press - + to choose or input your weight directly, press  to next step; 3, Time Setting(5-99): display remind "ENTER TIME"(input time) default "30min" press - + to choose or input time directly, press to  "PRESS START BEGIN."

Target program starting up

Press  button, display remind "SET TIME OR ENTER THE NEXT TARGET" same time, Time Window Flashes. Default time 30min; setting interval 5:00-99.00; adjust with - + button, 1min each press or use numeric keypad to setting detail time, press  , display remind "PRESS START TO BEGIN", press  to start the unit.

Press  button, display remind "SET DISTANCE OR ENTER THE NEXT TARGET" Same Time, Distance window flashes. Default setting 1.0Km, setting interval 1-99; setting with - + button, 1km each press, or use numeric keypad to setting detail distance, After press  , display remind "PRESS START TO BEGIN", press  button to start.

Press  button, display remind "SET CALORIES OR ENTER THE NEXT TARGET" same time, Calories window flashes, default setting 50Kcal; Setting interval 50-990; setting with - + button, 10Kcal each press, or use numeric keypad to setting detail calories, press  button, display remind "PRESS START TO BEGIN", press  button to start.

EXERCISE INSTRUCTIONS

Operating Instructions

Self-Editing program starting up

Press **[M]** Button, display remind "USER PROGRAM" After the information finished, the first line of display is displayed. The first light flashes, setting with - +, each press 1lvl, or use numeric keypad to setting details, press **[OK]** to next step, when finish last step, press **[OK]**, display remind "ENTER TIME", press **[OK]**, display remind "PRESS START TO BEGIN", press **[Start]** to begin exercise.

Exercise instructions

Medical research results show that, Certain exercise can promote the recovery of our cardiopulmonary system and muscle tissue. At the same time, it is safe and effective to control the exercise intensity to 60%-85% of the maximum heart rate during fitness exercise. Because this interval can fully achieve the effect of different needs, And it does not cause damage caused by excessive exercise, etc.

Maximum heart rate and exercise heart rate interval

Please use the following formula to calculate the maximum heart rate and exercise interval (Taking 35 years old as an example):

Max heart rate = $220 - \text{age}$ ($220 - 35 = 185/\text{min}$)

Exercise heart rate upper limit = max heart rate * 85% ($185 * 85\% = 157 \text{ times/min}$)

Exercise heart rate lower limit = max heart rate * 60% ($185 * 60\% = 111 \text{ times/min}$) Then

the exercise heart rate interval is 111-157 times / minute

Heart Rate Target Zones

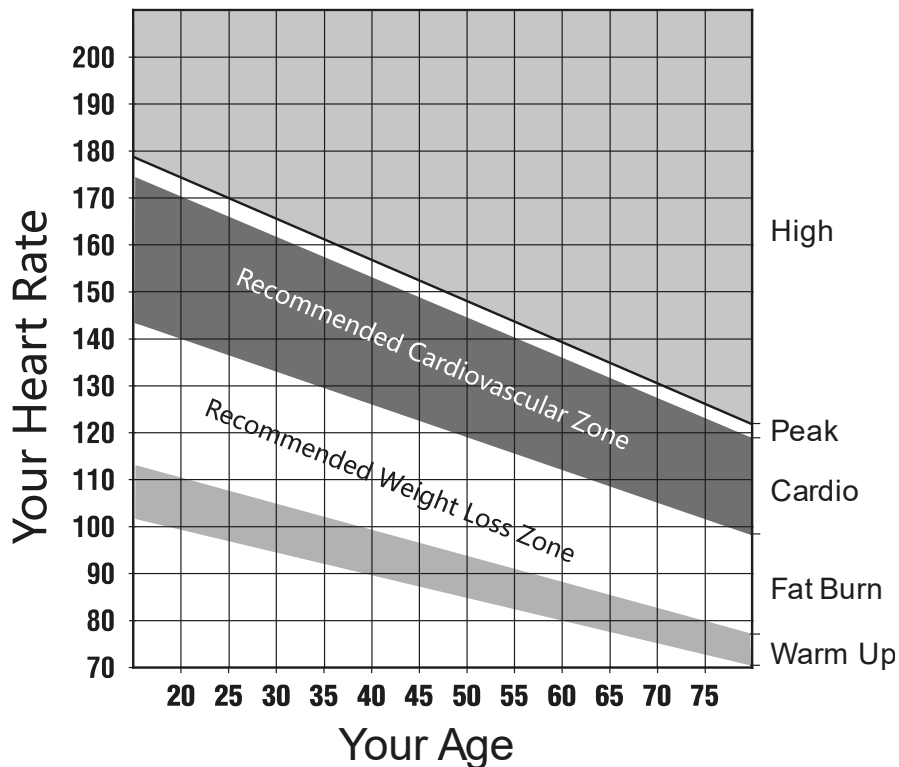

MAINTENANCE

WARNING

- To reduce the risk of electrical shock, always unplug the equipment from its powersource before cleaning it or performing any maintenance tasks.
- Cleaning console and screen
- Use mild soap and water to dampen a soft cloth and wipe all exposed surfaces. CAUTION: Do not use any acidic cleaners. Doing so will weaken the paint or powder coating. Never pour water or spray liquids on any part of the equipment.
- Avoid any corrosive chemicals on console and screen
Water to dampen a soft cloth and then clean the screen.
- Make sure to spray the cleaning solution on the soft cloth, not console.
- Do not use a hard cloth to clean

Specification

Max User Weight: 330lbs (150kg)

24V === 4A

Resistance Level:25